

PMUB 5000 · 7000 series 3 ports 2 positions pilot valve

Operating specification and Order expression

CHELIC PNEUMATIC

Internal structure

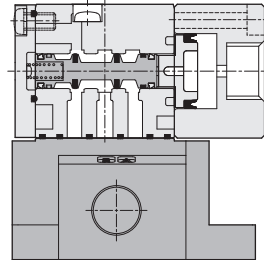

PM
Pilot Valve

PMB
Pilot Valve

PMU
Pilot Valve

PMUB
Pilot Valve

PV
Pilot Valve

PN
Pilot Valve

Specification

Item	Model	PMUB5000	PMUB7000
Fluid		Air	
Pressure range	kgf/cm ² (Kpa)	1.5 ~ 7 (150 ~ 700)	
Range of temperature	°C	0 ~ 60	
Operating method		Air pilot	
Number of positions ports		3 ports 2 positions	3 ports 2 positions
Valve function		Normal closed / Normal open	
Orifice	mm ² (CV)	3.06 (0.17)	11.7 (0.65)
Connection port		M5,Rc1/8"	Rc1/8",Rc1/4"
Lubrication		Lubrication free type	

How to order

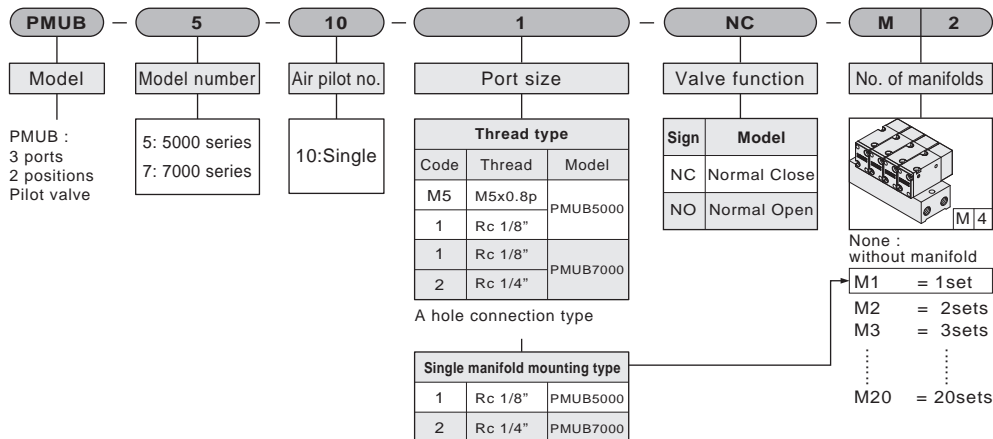

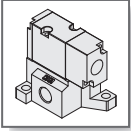

PMUB 5000 ~ 7000 series 3 ports 2 positions pilot valve

Component and Material list

CHELIC PNEUMATIC

- Single air pilot 3 ports 2 positions

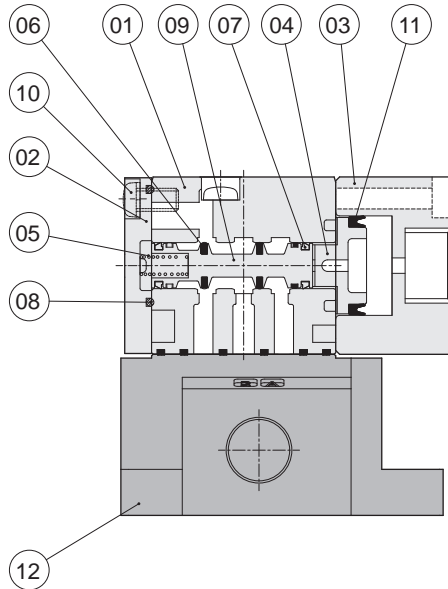
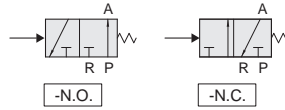

Material of major parts list

NO.	Item	Material	NO.	Item	Material
01	Body	Aluminum alloy	7	Packing	NBR
02	End cover	Aluminum alloy	8	End cover seal ring	NBR
03	Air pilot holder	Aluminum alloy	9	Rod	Aluminum alloy
04	Holder piston	POM	10	Screw	Alloy steel
05	End cover spring	Stainless steel	11	Packing	NBR
06	Packing	NBR	12	Single base	Aluminum alloy

Note : Body is treaded with baked painting .

Packing and O-Ring

Item		Holder piston packing	Back cover piston packing
Model	Number	1	1
	PMUB 5000	MYA-10	MYA-7
	PMUB 7000	MYA-11	MYA-7

Note : Piston packing and Rod packing are imported. (MITSUBISHI , SAKAGAMI and so on)

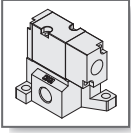

PMUB series - PMUB 5000

3 ports 2 positions pilot valve

External dimensions / Mounting type

CHELIC PNEUMATIC

PMUB 5101 - □

Single exhaust-from-base - Mounting type
 Single air pilot
 3 ports 2 positions

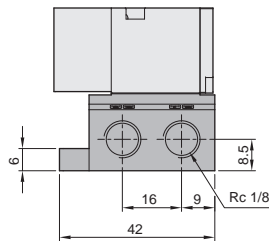
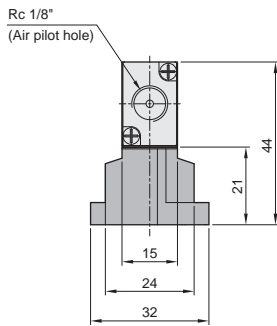
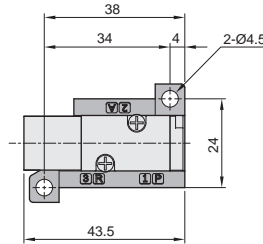
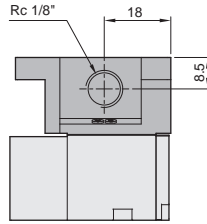
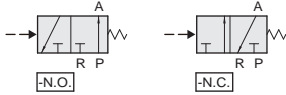

PM
Pilot Valve

PMB
Pilot Valve

PMU
Pilot Valve

PMUB
Pilot Valve

PV
Pilot Valve

PN
Pilot Valve

PMUB 5000 series - Standard type

Size of exhaust - from - base manifold

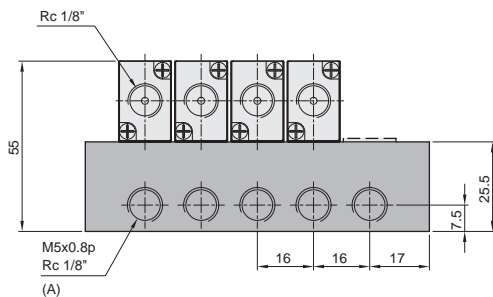
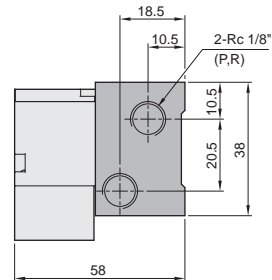
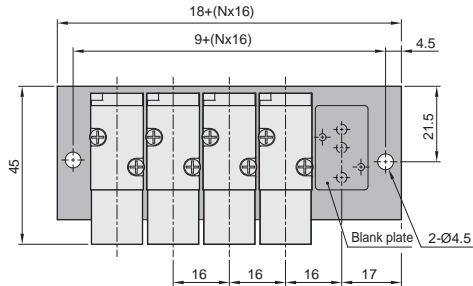

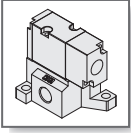

PMUB series - PMUB 7000

3 ports 2 positions pilot valve

External dimensions / Mounting type

CHELIC PNEUMATIC

PMUB 7102 - □

Single exhaust-from-base - Mounting type
 Single air pilot
 3 ports 2 positions

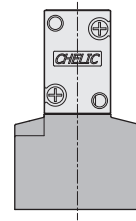
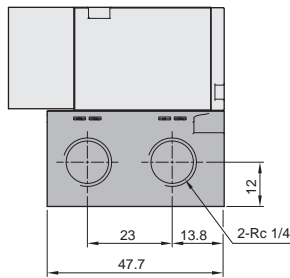
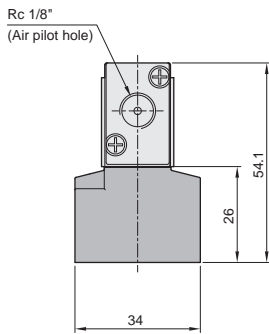
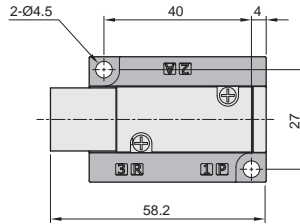
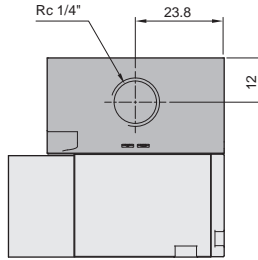
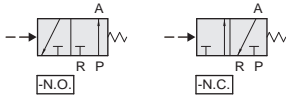

PMUB 7000 series - Standard type

Size of exhaust - from - base manifold

