

SMU series 3/2 Body Ported Solenoid Valve

Product features

CHELIC

Internal structure

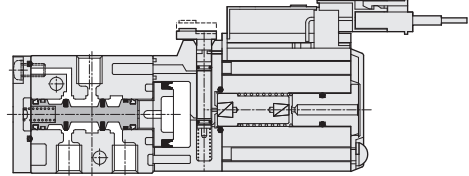
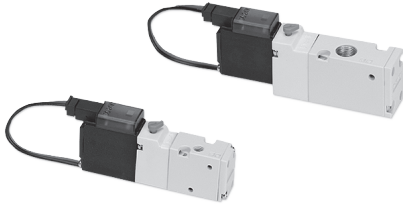

Specification

| Item | Model | SMU5000 | SMU7000 |
|-------------------------------|---------------------------|--------------------------------|-----------|
| Fluid | | Air | |
| Pressure range | kgf/cm ² (kPa) | 1.5 ~ 7 (150 ~ 700) | |
| Ambient and fluid temperature | ℃ | 5 ~ 60 | |
| Pilot type | | Air operated | |
| Number of positions | | 3/2-position | |
| Type of actuation | | Normally closed/ Normally open | |
| Effective orifice | mm ² (CV) | 2.16(0.12) | 12.6(0.7) |
| Manual override | | Push and lock | |
| Port size | | M5 | Rc1/8 |
| Lubrication | | Lubrication free type | |

Code of order

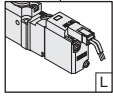
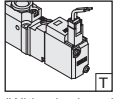
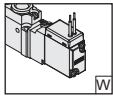
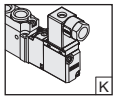
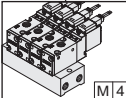
| SMU | 5 | 10 | 1 | NC | 110 | L | M | 2 | | | | | | | | | | | | | | | |
|---|----------------------------------|------------|--|------------|------------|------------------|----------|----------|---------|---|--------|---------|---|------|-------|----|-----------------|----|---------------|--|---|--|--|
| Model | Model number | Coil q'ty | Port size | Valve type | Voltage | Electrical entry | Manifold | | | | | | | | | | | | | | | | |
| SMU: 3 port 2-position Solenoid valve | 5: 5000 series 7: 7000 series | 10: Single | <table border="1"> <thead> <tr> <th>Mark</th> <th>Thread</th> <th>Model</th> </tr> </thead> <tbody> <tr> <td>M5</td> <td>M5x0.8p</td> <td>SMU5000</td> </tr> <tr> <td>1</td> <td>Rc 1/8</td> <td>SMU7000</td> </tr> </tbody> </table> <p>For A port connection</p> | Mark | Thread | Model | M5 | M5x0.8p | SMU5000 | 1 | Rc 1/8 | SMU7000 | <table border="1"> <thead> <tr> <th>Mark</th> <th>Model</th> </tr> </thead> <tbody> <tr> <td>NC</td> <td>Normally closed</td> </tr> <tr> <td>NO</td> <td>Normally open</td> </tr> </tbody> </table> | Mark | Model | NC | Normally closed | NO | Normally open | Standard : 12V DC 1.5W 24V DC 1.5W 110V AC 0.9VA 220V AC 1.8VA |  (With wire length 300mm)  (With wire length 300mm)  Grommet (With wire length 300mm)  DIN Terminal |  None: Without manifold M2 = 2 sets M3 = 3 sets M20 = 20 sets | |
| Mark | Thread | Model | | | | | | | | | | | | | | | | | | | | | |
| M5 | M5x0.8p | SMU5000 | | | | | | | | | | | | | | | | | | | | | |
| 1 | Rc 1/8 | SMU7000 | | | | | | | | | | | | | | | | | | | | | |
| Mark | Model | | | | | | | | | | | | | | | | | | | | | | |
| NC | Normally closed | | | | | | | | | | | | | | | | | | | | | | |
| NO | Normally open | | | | | | | | | | | | | | | | | | | | | | |

SMU series 3/2 Body Ported Solenoid Valve

Product features

CHELIC

Internal structure

- 3 port 2-position single

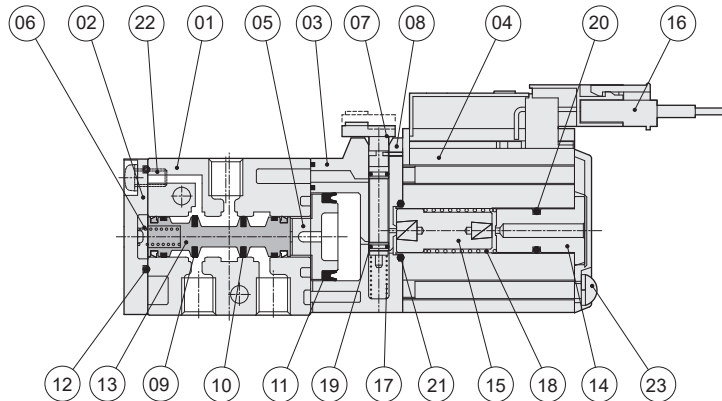
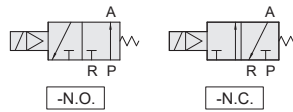

Components and Material list

| No. | Item | Material | No. | Item | Material |
|-----|-----------------------|-----------------|-----|----------------------------|-----------------|
| 01 | Main body | Aluminum alloy | 13 | Shaft | Aluminum alloy |
| 02 | Rear cover | Resin | 14 | Coil insert bushing | Stainless steel |
| 03 | Holder | Resin | 15 | Spring bushing | Stainless steel |
| 04 | Coil | — | 16 | Wire plug | Resin |
| 05 | Holder piston | POM | 17 | Manual override spring | Stainless steel |
| 06 | Rear cover spring | Stainless steel | 18 | Spring bushing spring | Stainless steel |
| 07 | Manual override | POM | 19 | Manual override O-Ring | NBR |
| 08 | Position iron plate | Iron | 20 | Coil insert bushing O-ring | NBR |
| 09 | Spool packing | NBR | 21 | O-Ring | NBR |
| 10 | Spool packing | NBR | 22 | Rear screw | Alloy steel |
| 11 | Holder piston packing | NBR | 23 | Coil cover screw | Alloy steel |
| 12 | Rear cover O-ring | NBR | | | |

Note: The main body has been treated with painting.

Packing and O-Ring material list

| Item | Holder piston packing | Rear cover packing | Manual rod O-Ring | Coil insert bushing O-ring |
|------------------|-----------------------|--------------------|-------------------|----------------------------|
| Model \ Quantity | 1 | 1 | 1 | 1 |
| SMU 5000 | MYA-10 | MYA-7 | Ø2xØ0.6 | Ø4.6xØ1 |
| SMU 7000 | MYA-11 | MYA-7 | Ø2xØ0.6 | Ø4.6xØ1 |

Note: Piston packing and rod packing all adopt import parts (MITSUBISHI, SAKAGAH, and same grade).

ISO

SRU

SRUB

SMU

SMUB

SKU

SKB

SKV

SV310

SWB

SMU 500 series 3/2 Body Ported Solenoid Valve

Dimensions/ Standard

CHELIC

SMU 510M5 - □

3 port 2-position single

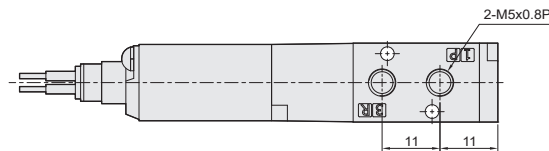
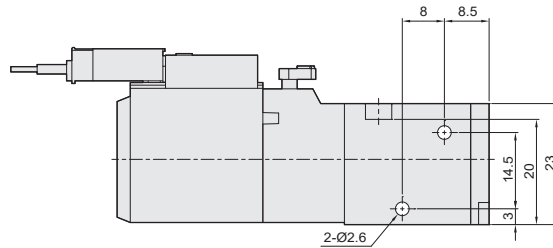
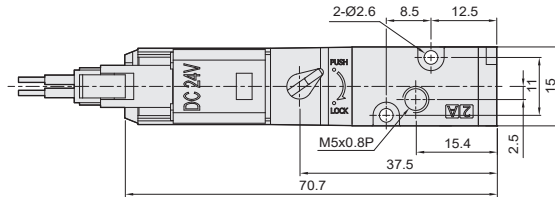
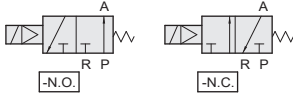

L wire type - □

T wire type - □

W wire type - □

K wire type - □

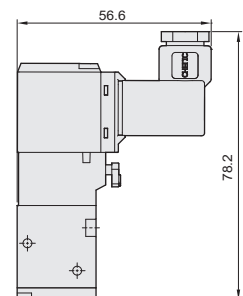
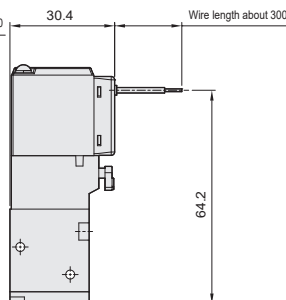
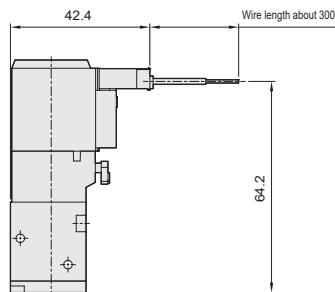
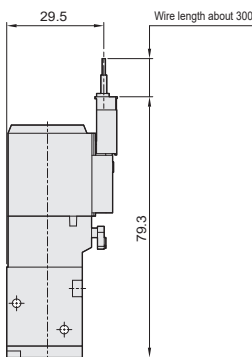

SMU 700 series 3/2 Body Ported Solenoid Valve

Dimensions/ Standard

CHELIC

SMU 7101 - □

3 port 2-position single

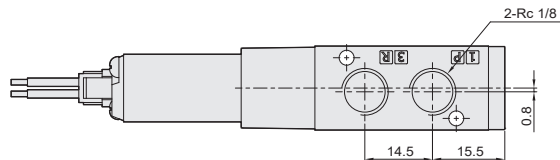
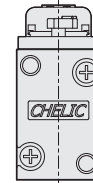
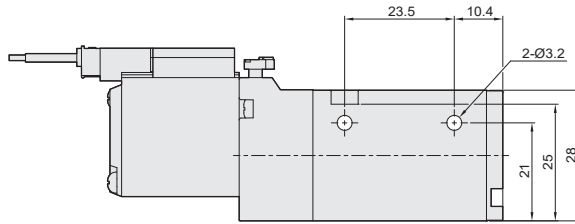
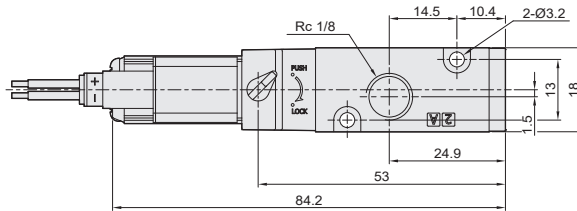
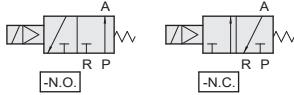

L wire type - □

T wire type - □

W wire type - □

K wire type - □

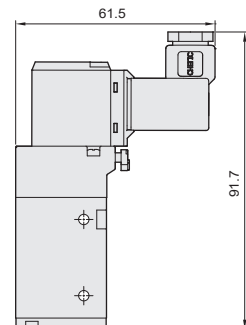
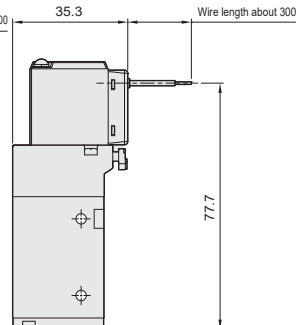
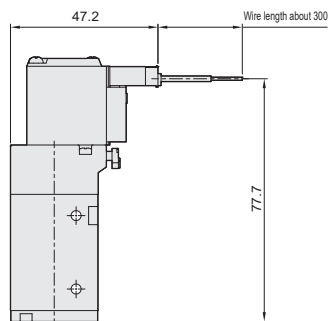
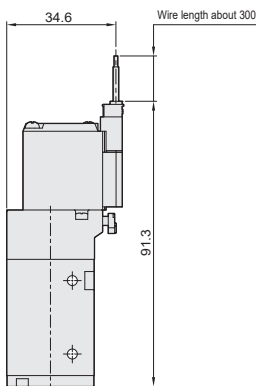

ISO

SRU

SRUB

SMU

SMUB

SKU

SKB

SKV

SV310

SWB

SMU series 3/2 Body Ported Solenoid Valve

Dimensions/ Manifold type

CHELIC

SMU 5000 series - standard

Manifold dimension

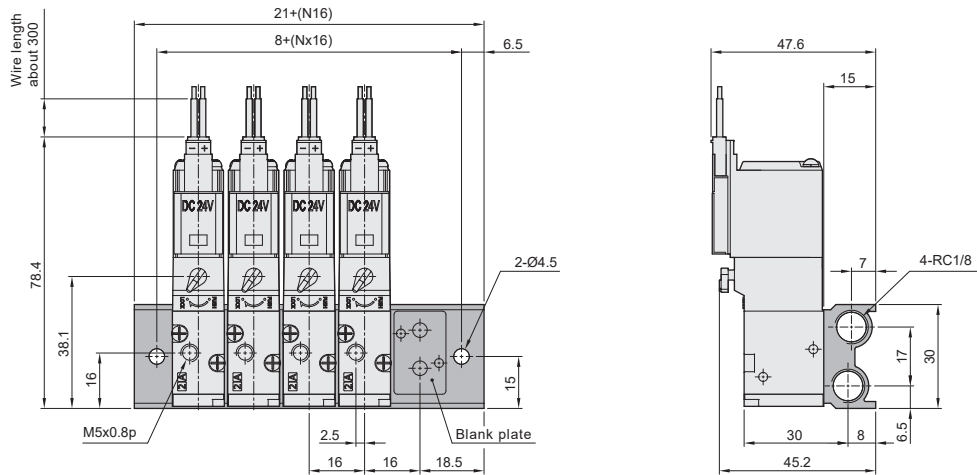

Note: Blank plate with rubber lining is reserved for temporary storage space of solenoid valves.

SMU 7000 series - standard

Manifold dimension

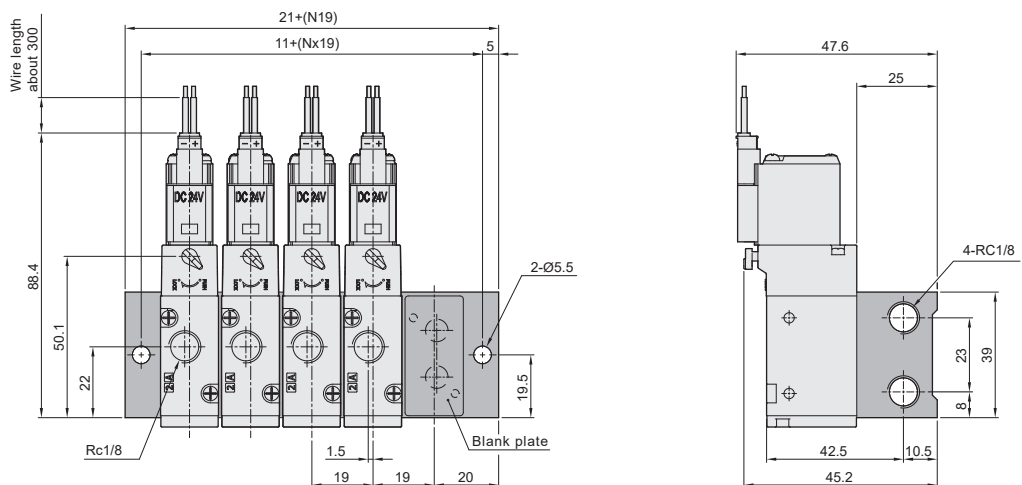

Note: Blank plate with rubber lining is reserved for temporary storage space of solenoid valves.

SMU series 3/2 Body Ported Solenoid Valve

Accessories/ Installation

CHELIC

Manifold

SMU - 5000 • 7000 series

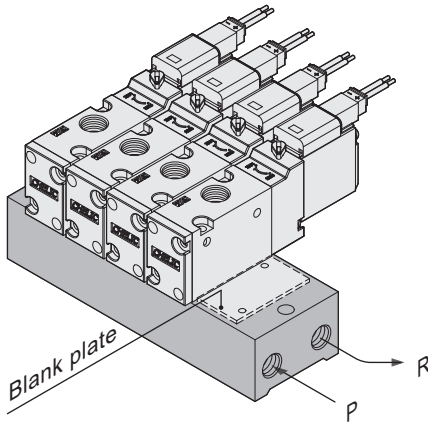

Manifold accessory

SMU - 5000 • 7000 series

※ The accessories of blank plate.

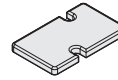
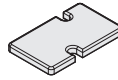

Blank plate

SMU-5000 series

MSMU05041

SMU-7000 series

MSMU07041

Rubber lining

MSMU05039

MSMU07039

Mounting screw

M2.6X6.5L MSMU05040

M3X8L MSMU07040

ISO

SRU

SRUB

SMU

SMUB

SKU

SKB

SKV

SV310

SWB

With indicator light: all this series with indicator light and voltage protection circuit

